



# **GORREUX**

## **PROGRAMME DE VENTES ONZE GAMMA**

**Rue de l'Ourchet, 7  
B - 5030 BEUZET - GEMBLOUX (Belgium)**

**Tel. +32 (0)81 - 56 71 91**

**Fax +32 (0)81 - 56 77 91**

**e-mail : [infog@gorreux.be](mailto:infog@gorreux.be)**

**[www.gorreux.be](http://www.gorreux.be)**

# **GORREUX**

## ***CLES***

## ***SLEUTELS***







<http://www.gorreux.be>

Sous réserve de modifications techniques - technische wijzigingen voorbehouden

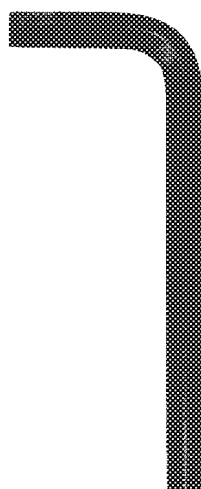
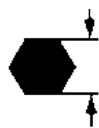
ISO 2936 C

CHROME VANADIUM, trempée et à teinte brunie par revenu  
CHROOM-VANADIUM, uitv. gehard, ontlaten en gezwart







CODE	 mm	 pouce / duim	 mm	
4257	0,7	0,028	33 X 8	0,14
4258	0,9	0,035	33 X 10	0,2
4259	1,3	0,05	40 X 12	0,7
4235	1,5		45 X 14	0,9
4236	2	5 / 64	50 X 16	1,8
4237	2,5		56 X 18	3
4238	3		63 X 20	5
4239	4	5 / 32	70 X 25	10
4240	5		80 X 28	18
4241	6		90 X 32	30
4242	7	9 / 32	95 X 34	43
4243	8	5 / 16	100 X 36	59
4244	9		106 X 38	79
4245	10		112 X 40	103
4246	11	7 / 16	118 X 42	131
4247	12		125 X 45	160
4248	14		140 X 55	260
4249	17		160 X 63	430
4250	19	3 / 4	180 X 70	617
4251	22	7 / 8	200 X 80	920
4252	24		224 X 90	1238
4253	27		250 X 100	1740
4254	30		285 X 112	2410
4255	32		315 X 125	3080
4256	36		355 X 140	4370

DIN 911 LC ISO 2936 LC

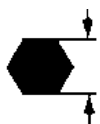
serie longue - lang uitvoering

CHROME VANADIUM, trempée et à teinte brunie par revenu  
CHROOM-VANADIUM, uitv. gehard, ontlaten en gezwart







CODE	 mm	 pouce / duim	 mm	
4382	1,5		90 X 14	1,5
4371	2	5 / 64	100 X 16	3
4372	2,5		112 X 18	5,5
4373	3		126 X 20	9
4374	4	5 / 32	142 X 25	18
4375	5		160 X 28	32
4376	6		180 X 32	52
4377	7	9 / 32	190 X 34	74
4378	8	5 / 16	200 X 36	100
4379	10		224 X 40	177
4380	12		250 X 45	287
4381	14		280 X 56	440

ISO 2936 D

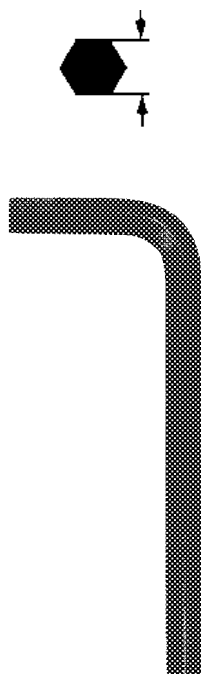
CHROME VANADIUM, trempée et nickelée.

CHROOM-VANADIUM, uitv. gehard, en vernikkeld





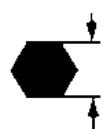

CODE	 mm	 pouce / duim	 mm	
4259	1,3	0,05	40 X 12	0,7
4263	1,5		45 X 14	0,9
4264	2	5 / 64	50 X 16	1,8
4265	2,5		56 X 18	3
4266	3		63 X 20	5
4267	4	5 / 32	71 X 25	10
4268	5		80 X 28	18
4269	6		90 X 32	30
4270	7	9 / 32	95 X 34	43
4271	8	5 / 16	100 X 36	59
4272	9		105 X 38	79
4273	10		112 X 40	103
4274	11	7 / 16	118 X 42	131
4275	12		125 X 45	160
4276	14		140 X 55	260
4277	17		160 X 60	430
4278	19	3 / 4	180 X 70	617
4279	22	7 / 8	200 X 80	920

CHROME VANADIUM, trempée et à teinte brunie par revenu

CHROOM-VANADIUM, uitv. gehard, ontlaten en gezwart







CODE	 pouce / duim	 mm	 mm	
4329	0,05	1,27	40 X 12	0,7
4330	1/16	1,59	45 X 14	1
4264	5/64	1,98	50 X 16	1,8
4332	3/32	2,38	53 X 18	2
4333	1/8	3,18	58 x 20	5
4349	9/64	3,57	61 x 21	7
4267	5/32	3,97	70 x 25	10
4335	3/16	4,76	71 x 25	15
4336	7/32	5,56	79 x 28	23
4337	1/4	6,35	88 x 31	31
4359	9/32	7,14	95 x 34	43
4271	5/16	7,94	100 x 36	59
4340	3/8	9,53	107 x 39	92
4274	7/16	11,11	118 x 42	131
4342	1/2	12,70	130 x 46	206
4343	9/16	14,29	144 x 50	280
4344	5/8	15,88	159 x 55	350
4278	3/4	19,05	180 x 70	617
4279	7/8	22,23	200 x 80	920
4347	1	25,40	225 x 90	1390



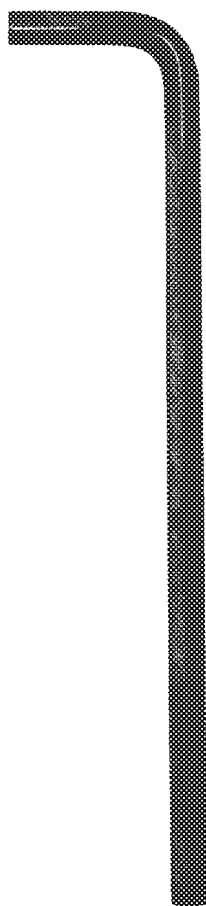

ISO 2936 LD

CHROME VANADIUM, trempée et nickelée.

CHROOM-VANADIUM, uitv. gehard, en vernikkeld



CODE	 mm	 pouce / duim	 mm	
4288	1,5		90 X 14	1,5
4289	2	5 / 64	100 X 16	3
4290	2,5		112 X 18	5,5
4291	3		126 X 20	9
4293	4	5 / 32	142 X 25	18
4294	5		160 X 28	32
4295	6	5 / 16	180 X 32	52
4287	7	9 / 32	190 x 34	74
4296	8		200 X 36	100
4297	10		224 X 40	177
4362	11	7 / 16	236 x 42	228
4298	12		250 X 45	287
4299	14		280 X 56	440
4300	17		320 X 63	750
4301	19	3 / 4	360 X 70	1100

CODE	 pouce / duim	 mm	 mm	
4417	5 / 64	1,98	100 x 16	3
4418	3/32	2,38	106 x 18	3,5
4419	1/8	3,18	116 x 20	7,4
4420	9/64	3,57	122 x 21	12
4421	5/32	3,97	140 x 25	18
4422	3/16	4,76	142 x 25	26
4423	7/32	5,56	158 x 28	40
4424	1/4	6,35	176 x 31	54
4425	9/32	7,14	190 x 34	74
4426	5/16	7,94	200 x 36	100
4427	3/8	9,53	214 x 39	156
4428	7/16	11,11	236 x 42	228
4429	1/2	12,70	260 x 46	360
4430	3/4	19,05	360 x 70	1100



906S





CLE POUR SIX-PANS CREUX à petite poignée  
ZESKANTSCHROEVENDRAAIERS met dwarsgreep



CHROME VANADIUM, trempée et à teinte brunie par revenu

CHROOM-VANADIUM, uitv. gehard, ontlaten en gezwart



CODE						
	mm	pouce				
4755	1,5		60	95	40	9
4556	2	5/64"	60	95	40	10
4357	2,5		60	95	40	11
4158	3		60	95	40	12

906H







CLE POUR SIX-PANS CREUX à petite poignée  
ZESKANTSCHROEVEDRAAIERS met dwarsgreep



CHROME VANADIUM, trempée et nickelée.

CHROOM-VANADIUM, uitv. gehard, en vernikkeld



CODE							
	mm	pouce					
4625	2	5/64"	30	16	105	16	29
4626	2,5		32	18	107	16	30
4627	3		35	20	110	16	27
4628	4	5/32"	40	25	115	16	32
4629	5		45	28	130	18	52
4630	6		50	32	145	21	75
4631	8	5/16"	60	36	155	24	126
4632	10		75	40	190	27	198
4633	12		85	45	190	27	218

906QL







CLE POUR SIX-PANS CREUX à poignée  
ZESKANTSCHROEVENDRAAIERS met dwarsgreep



CHROME VANADIUM, trempée et nickelée.

CHROOM-VANADIUM, uitv. gehard, en vernikkeld



CODE							
	mm	pouce					
4510	4	5/32"	150	15	85	171	37
4511	5		150	20	110	176	67
4512	6		150	20	110	176	81
4513	8	5/16"	200	25	115	226	148
4514	10		200	30	140	230	260
4515	12		250	30	140	280	395

95

906Q

CLE POUR SIX-PANS CREUX à poignée  
ZESKANTSCHROEVENDRAAIERS met dwarsgreep





GORREUX



CHROME VANADIUM, trempée et nickelée.

CHROOM-VANADIUM, uitv. gehard, en vernikkeld



CODE						A/A
	mm	pouce				
4531	2	5/64"	100	80	125	18
4532	2,5		100	80	125	24
4530	2,5		200	80	225	30
4533	3		100	80	125	24
4534	3		150	80	175	30
4535	3		200	80	225	32
4536	4	5/32"	100	80	125	31
4537	4	5/32"	150	80	175	36
4538	4	5/32"	200	80	225	41
4555	4	5/32"	300	80	325	50
4539	5		100	100	131	51
4540	5		150	100	181	60
4541	5		200	100	231	68
4554	5		350	100	381	100
4542	6		100	100	131	58
4543	6		150	100	181	77
4544	6		200	100	231	84
4556	6		350	100	381	130
4545	8	5/16"	100	100	131	85
4546	8	5/16"	150	100	181	105
4547	8	5/16"	200	100	231	125
4557	8	5/16"	350	100	381	200
4548	10		100	120	138	165
4549	10		200	120	238	223
4558	10		350	120	388	350
4550	12		100	120	138	209
4551	12		200	120	238	307

906





CLE POUR SIX-PANS CREUX  
ZESKANTSCHROEVENDRAAIERS

GORREUX

CHROME VANADIUM, trempée et nickelée.

CHROOM-VANADIUM, uitv. gehard, en vernikkeld



CODE						A/A
	mm	pouce				
4520	1,5		90	72	16 x 25	18
4521	2	5/64"	90	72	16 x 25	21
4522	2,5		90	72	16 x 25	24
4523	3		90	72	16 x 25	26

96

Sous réserve de modifications techniques - technische wijzigingen voorbehouden

906WM7



JEUX DE CLE POUR SIX-PANS CREUX  
STELLEN ZESKANTSCHROEVENDRAAIERS

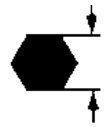

CHROME VANADIUM, trempée et nickelée.  
CHROOM-VANADIUM, uitv. gehard, en vernikkeld



Support : métal, plastifié

CODE	N°				△△
4228	906-WM 7 M	906 - 2X90 - 2,5X90 - 3X90			955
		906Q - 4X150 - 5X150 - 6X200 - 8X200			
4230	906 WM 9 M	906 - 1,5x90 - 2X90 - 2,5X90 - 3X90			1400
		906Q - 4X150 - 5X150 - 6X200 - 8X200 - 10X200			

906QWM7



JEUX DE CLE POUR SIX-PANS CREUX  
STELLEN ZESKANTSCHROEVENDRAAIERS

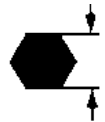

CHROME VANADIUM, trempée et nickelée.  
CHROOM-VANADIUM, uitv. gehard, en vernikkeld



Support : matière plastique

CODE	N°				△△
4229	906Q-WM 7	906 - 2X100 - 2,5X100 - 3X150 - 4X150 - 5X150			575
		6X150 - 8X150			
4231	906 WM 9	906 - 1,5x90 - 2X90 - 2,5X90 - 3X90			860
		906Q - 4X150 - 5X150 - 6X200 - 8X200 - 10X200			

911WM9M



JEUX DE CLE POUR SIX-PANS CREUX  
STELLEN ZESKANTSCHROEVENDRAAIERS

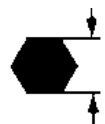

CHROME VANADIUM, trempée et nickelée.  
CHROOM-VANADIUM, uitv. gehard, en vernikkeld













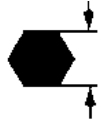











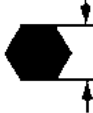

Support : métal, plastifié











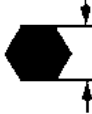

CODE	N°			△△
4403	911-WM 9 M	2,5 - 3 - 4 - 5 - 6 - 8 - 10 - 12 - 14		1200
4404	911L-WM9M	2,5 - 3 - 4 - 5 - 6 - 8 - 10 - 12 - 14		1570

avec clés din 911 - met zeskantschroevendraaiers din 911 - ISO 2936



<b>911WM9</b>	<b>JEUX DE CLE POUR SIX-PANS CREUX STELLEN ZESKANTSCHROEVENDRAAIERS</b>													
	<p>CHROME VANADIUM, trempée et nickelée. CHROOM-VANADIUM, uitv. gehard, en vernikkeld</p> <p>Support : matière plastique</p>													
	<table border="1" style="width: 100%; border-collapse: collapse;"> <thead> <tr> <th style="width: 10%;">CODE</th> <th style="width: 10%;">N°</th> <th style="width: 60%;"> </th> <th style="width: 20%;"></th> </tr> </thead> <tbody> <tr> <td style="text-align: center;">4407</td> <td style="text-align: center;">911-WM 9</td> <td style="text-align: center;">2,5 - 3 - 4 - 5 - 6 - 8 - 10 - 12 - 14</td> <td style="text-align: center;">840</td> </tr> <tr> <td style="text-align: center;">4408</td> <td style="text-align: center;">911L-WM9</td> <td style="text-align: center;">2,5 - 3 - 4 - 5 - 6 - 8 - 10 - 12 - 14</td> <td style="text-align: center;">1200</td> </tr> </tbody> </table>	CODE	N°	 		4407	911-WM 9	2,5 - 3 - 4 - 5 - 6 - 8 - 10 - 12 - 14	840	4408	911L-WM9	2,5 - 3 - 4 - 5 - 6 - 8 - 10 - 12 - 14	1200	
CODE	N°	 												
4407	911-WM 9	2,5 - 3 - 4 - 5 - 6 - 8 - 10 - 12 - 14	840											
4408	911L-WM9	2,5 - 3 - 4 - 5 - 6 - 8 - 10 - 12 - 14	1200											
avec clés din 911 - met zeskantschroedraaiers din 911 - ISO 2936														

<b>911HM</b>	<b>JEUX DE CLE POUR SIX-PANS CREUX STELLEN ZESKANTSCHROEVENDRAAIERS</b>																					
	<p>CHROME VANADIUM, trempée et nickelée. CHROOM-VANADIUM, uitv. gehard, en vernikkeld</p>																					
	<table border="1" style="width: 100%; border-collapse: collapse;"> <thead> <tr> <th style="width: 10%;">CODE</th> <th style="width: 10%;">N°</th> <th style="width: 60%;"> </th> <th style="width: 20%;"></th> </tr> </thead> <tbody> <tr> <td style="text-align: center;">4901</td> <td style="text-align: center;">911HM6D</td> <td style="text-align: center;">1,5 - 2 - 2,5 - 3 - 4 - 5</td> <td style="text-align: center;">47</td> </tr> <tr> <td style="text-align: center;">4902</td> <td style="text-align: center;">911HM9D</td> <td style="text-align: center;">1,5 - 2 - 2,5 - 3 - 4 - 5 - 6 - 8 - 10</td> <td style="text-align: center;">245</td> </tr> <tr> <td style="text-align: center;">4620</td> <td style="text-align: center;">911L-HM9C</td> <td style="text-align: center;">1,5 - 2 - 2,5 - 3 - 4 - 5 - 6 - 8 - 10</td> <td style="text-align: center;">415</td> </tr> <tr> <td style="text-align: center;">4906</td> <td style="text-align: center;">911L-HM9D</td> <td style="text-align: center;">1,5 - 2 - 2,5 - 3 - 4 - 5 - 6 - 8 - 10</td> <td style="text-align: center;">415</td> </tr> </tbody> </table>	CODE	N°	 		4901	911HM6D	1,5 - 2 - 2,5 - 3 - 4 - 5	47	4902	911HM9D	1,5 - 2 - 2,5 - 3 - 4 - 5 - 6 - 8 - 10	245	4620	911L-HM9C	1,5 - 2 - 2,5 - 3 - 4 - 5 - 6 - 8 - 10	415	4906	911L-HM9D	1,5 - 2 - 2,5 - 3 - 4 - 5 - 6 - 8 - 10	415	
CODE	N°	 																				
4901	911HM6D	1,5 - 2 - 2,5 - 3 - 4 - 5	47																			
4902	911HM9D	1,5 - 2 - 2,5 - 3 - 4 - 5 - 6 - 8 - 10	245																			
4620	911L-HM9C	1,5 - 2 - 2,5 - 3 - 4 - 5 - 6 - 8 - 10	415																			
4906	911L-HM9D	1,5 - 2 - 2,5 - 3 - 4 - 5 - 6 - 8 - 10	415																			
avec clés din 911 - met zeskantschroedraaiers din 911 - ISO 2936																						



<b>911RM</b>	<b>JEUX DE CLE POUR SIX-PANS CREUX STELLEN ZESKANTSCHROEVENDRAAIERS</b>									
	<p>CHROME VANADIUM, trempée et nickelée. CHROOM-VANADIUM, uitv. gehard, en vernikkeld</p>									
	<table border="1" style="width: 100%; border-collapse: collapse;"> <thead> <tr> <th style="width: 10%;">CODE</th> <th style="width: 10%;">N°</th> <th style="width: 60%;"> </th> <th style="width: 20%;"></th> </tr> </thead> <tbody> <tr> <td style="text-align: center;">4368</td> <td style="text-align: center;">911RM8</td> <td style="text-align: center;">2 - 2,5 - 3 - 4 - 5 - 6 - 8 - 10</td> <td style="text-align: center;">270</td> </tr> </tbody> </table>	CODE	N°	 		4368	911RM8	2 - 2,5 - 3 - 4 - 5 - 6 - 8 - 10	270	
CODE	N°	 								
4368	911RM8	2 - 2,5 - 3 - 4 - 5 - 6 - 8 - 10	270							
avec clés din 911 - met zeskantschroedraaiers din 911 - ISO 2936										

<b>911TM</b>	<b>JEUX DE CLE POUR SIX-PANS CREUX STELLEN ZESKANTSCHROEVENDRAAIERS</b>	
--------------	---	---

CHROME VANADIUM, trempée et nickelée.

CHROOM-VANADIUM, uitv. gehard, en vernikkeld



CODE	N°	 	$\Delta \pm \Delta$
4385	911-TM 6	2 - 2,5 - 3 - 4 - 5 - 6	85
4386	911-TM 8	2 - 2,5 - 3 - 4 - 5 - 6 - 8 - 10	250
4387	911-TM10	2 - 2,5 - 3 - 4 - 5 - 6 - 8 - 10 - 12 - 14	660
4388	911L-TM7	2 - 2,5 - 3 - 4 - 5 - 6 - 8	240



avec clés din 911 - met zeskantschroedraaiers din 911 - ISO 2936

<b>911LBM8</b>	<b>JEUX DE CLE POUR SIX-PANS CREUX STELLEN ZESKANTSCHROEVENDRAAIERS</b>	
----------------	---	---

CHROME VANADIUM, trempée et nickelée.

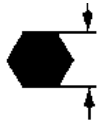
CHROOM-VANADIUM, uitv. gehard, en vernikkeld



CODE	N°	 	L X B X H	$\Delta \pm \Delta$
4600	911L-BM8	2 - 2,5 - 3 - 4 - 5 - 6 - 8 - 10	265 X 88 X 17	270



avec clés din 911 - met zeskantschroedraaiers din 911 - ISO 2936

<b>911BM7</b>	<b>JEUX DE CLE POUR SIX-PANS CREUX STELLEN ZESKANTSCHROEVENDRAAIERS</b>	
---------------	---	---

CHROME VANADIUM, trempée et nickelée.

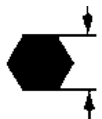
CHROOM-VANADIUM, uitv. gehard, en vernikkeld



CODE	N°	 	L X B X H	$\Delta \pm \Delta$
4482	911BM7	2 - 2,5 - 3 - 4 - 5 - 6 - 8	133 X 72 X 14	185

avec clés din 911 - met zeskantschroedraaiers din 911 - ISO 2936

911BM10



## JEU DE CLES POUR SIX-PANS CREUX

### Set zeskantsleutels



CHROME VANADIUM, trempée et nickelée.  
CHROOM-VANADIUM, uitv. gehard, en vernikkeld



CODE	N°	 	L X B X H	
4603	911BM10	2 - 2,5 - 3 - 4 - 5 - 6 - 8 - 10	177 X 88 X 17	320

avec clés din 911 - Met zeskantsleutels DIN 911 - ISO 2936

910

## JEU DE CLES MULTISERVICE



### Set zeskantsleutels







monture multiservice  
universeel gereedschap

CHROME VANADIUM, trempée et nickelée.  
CHROOM-VANADIUM, uitv. gehard, en vernikkeld



CODE	Grandeur / grootte		
4931	910 M6	95 X 28 X 25	180
4932	910 M8	95 X 25 X 25	180
4933	910 M9	95 X 28 X 25	180

Contenu / Inhoud		910 M6	910 M8	910 M9
	DIN 911	2, 2.5, 3, 4, 5 mm	2, 2.5, 3, 4, 5, 6 mm	1.5, 2, 2.5, 3, 4, 5, 6 mm
	DIN 5260	1,2 mm	1 mm	1 mm
	simil. / vgl. DIN 5264	0,5 X 3,5, 1 X 7 mm	1 X 7 mm	1 X 7 mm
	DIN 659	7, 8, 10, 13 mm	7, 8, 10, 13 mm	7, 8, 10, 13 mm

La MONTURE MULTISERVICE, le mini-atelier super pratique en format couteau de poche en trois variantes d'équipement. L'équipement complémentaire important pour utilisateurs professionnels et bricoleurs. Cet outil multiple tenant dans la paume de la main assure jusqu'à 14 fonctions.

Het universeel gereedschap: een superpraktisch miniatelier in zakmesformaat, in drie verschillende uitvoeringen. Een belangrijk stuk bijkomende uitrusting voor professionele gebruikers en knutselaars. Dit meervoudig gereedschap, dat men in de handpalm dient te houden, verzekert tot 14 functies.



DIN 6911

## CLE COUDEES A TETON POUR SIX-PANS WINKELHAAKSCHROEVENDRAAIERS



MET PEN VOOR SCHROEVEN DIN 6912 -POUR VIS DIN 6912 TETE BASSE  
CHROME VANADIUM, trempée et nickelée.  
CHROOM-VANADIUM, uitv. gehard, en vernikkeld



CODE	 mm	 mm	
4861	3	63 X 20	5
4862	4	70 X 25	10
4863	5	80 X 28	18
4864	6	90 X 32	30
4865	8	100 X 36	59
4866	10	112 X 40	103
4867	12	125 X 45	160
4868	14	140 X 56	260
4869	17	160 X 63	430



6911 BM7

## BOITE CLE COUDEES A TETON / SIX-PANS DOOS WINKELHAAKSCHROEVENDRAAIERS



CHROME VANADIUM, trempée et nickelée.  
CHROOM-VANADIUM, uitv. gehard, en vernikkeld



CODE	N°	 	L X B X H	
4486	DIN 6911 BM7	2 - 2,5 - 3 - 4 - 5 - 6 - 8	133 X 72 X 14	185

MET PEN VOOR SCHROEVEN DIN 6912 -POUR VIS DIN 6912 TETE BASSE

911LF

## CLE avec anneau POUR SIX-PANS CREUX

### Sleutel met ring voor zeskantbus Schroef

CHROME VANADIUM, trempée et nickelée. CHROOM-VANADIUM, uitv. gehard, en vernikkeld

La bague de retenue en acier à ressort de haute qualité, maintient la vis sur la tige de la clé dans n'importe quelle position de vissage. (Tête de vis suivant la norme DIN 912). Avantages: le maintien de la vis sur la clé permet de visser dans des endroits inaccessibles à la main. Pas besoin d'embout magnétique. Bénéfices: ces clés six pans mâles vous garantissent un accroissement de la sécurité de positionnement et de la rapidité de travail lors d'accès difficile. Différentes variantes proposées: - Clé simple ou à - poignée en té - sur porte-clés - sur stand.

De stalen houdring is van hoge kwaliteit, en houdt de schroef op de schacht van de sleutel in om het even welke positie (schroefkop volgens norm DIN 912). Pluspunten: het houden van de schroef op de sleutel laat toe te schroeven op plaatsen, ontoegankelijk voor de hand. Geen magnetisch opzetstuk nodig. Voordelen: deze mannelijke zeskant sleutels garanderen een toename in de positioneringszekerheid en de werksnelheid bij het werken op moeilijk toegankelijke plaatsen. Verschillende varianten: gewone sleutel, of met handvat in T-vorm, op sleuteldrager, op stand.



CODE	N°			
5306	911LF-HM 9 D	911L - 1,5 - 2 - 2,5 - 3	911LF - 4 - 5 - 6 - 8 - 10	420

CODE			
	mm	mm	
5301	4	140 X 25	18
5302	5	160 X 28	32
5303	6	180 X 32	52
5304	8	200 X 36	100
5305	10	224 X 40	177

911LGF

## CLE avec anneau POUR SIX-PANS CREUX

### Sleutel met ring voor zeskantbus Schroef

CHROME VANADIUM, trempée et nickelées. CHROOM-VANADIUM, uitv. gehard, en vernikkeld

La bague de retenue en acier à ressort de haute qualité, maintient la vis sur la tige de la clé dans n'importe quelle position de vissage. (Tête de vis suivant la norme DIN 912). Avantages: le maintien de la vis sur la clé permet de visser dans des endroits inaccessibles à la main. Pas besoin d'embout magnétique. Bénéfices: ces clés six pans mâles vous garantissent un accroissement de la sécurité de positionnement et de la rapidité de travail lors d'accès difficile. Différentes variantes proposées: - Clé simple ou à - poignée en té - sur porte-clés - sur stand.

De stalen houdring is van hoge kwaliteit, en houdt de schroef op de schacht van de sleutel in om het even welke positie (schroefkop volgens norm DIN 912). Pluspunten: het houden van de schroef op de sleutel laat toe te schroeven op plaatsen, ontoegankelijk voor de hand. Geen magnetisch opzetstuk nodig. Voordelen: deze mannelijke zeskant sleutels garanderen een toename in de positioneringszekerheid en de werksnelheid bij het werken op moeilijk toegankelijke plaatsen. Verschillende varianten: gewone sleutel, of met handvat in T-vorm, op sleuteldrager, op stand.



CODE	N°			
5346	911LGF-HM 9 D	911LG - 1,5 - 2 - 2,5 - 3	911LFG - 4 - 5 - 6 - 8 - 10	440

CODE			
	mm	mm	
5341	4	140 X 25	19
5342	5	160 X 28	34
5343	6	180 X 32	54
5344	8	200 X 36	110
5345	10	224 X 40	190

102

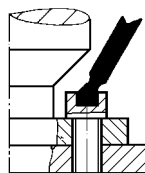

906QF WM 7

CLE avec anneau POUR SIX-PANS CREUX  
STELLEN ZESKANTSCHROEVENDRAAIERS





CHROME VANADIUM, trempée et nickelée.







CHROOM-VANADIUM, uitv. gehard, en vernikkeld

La bague de retenue en acier à ressort de haute qualité, maintient la vis sur la tige de la clé dans n'importe quelle position de vissage. (Tête de vis suivant la norme DIN 912). Avantages: le maintien de la vis sur la clé permet de visser dans des endroits inaccessibles à la main. Pas besoin d'embout magnétique. Bénéfices: ces clés six pans mâles vous garantissent un accroissement de la sécurité de positionnement et de la rapidité de travail lors d'accès difficile. Différentes variantes proposées: - Clé simple ou à - poignée en té - sur porte-clés - sur stand.

De houdring in veerstaal van hoge kwaliteit houdt de schroef in de schacht van de sleutel in om het even welke schroefpositie (schroefkop volgens norm DIN 912). Voordelen: het houden van de schroef op de sleutel laat het gebruik toe op plaatsen, ontoegankelijk voor de handen. Geen magnetisch hulpstuk nodig. Winst: deze mannelijke zeskantenschroevendraaiers bieden een verhoging van de positioneringszekerheid en de werksnelheid waar de toegang moeilijk is. Verschillende varianten beschikbaar: gewone sleutel of met T-handvat – op sleutelhanger – op stand.



CODE	N°			
5366	906QF WM 7	906Q 906QF 4X200-5X200-6X200-8X200-10X100	- 2,5x200 - 3x100	1130

CODE	 mm	 pouce/duim				
5361	4	5/32	200	80	225	41
5362	5		200	100	231	68
5363	6		200	100	231	84
5364	8	5/16	200	100	231	125
5365	10		200	120	238	223



911LG-C

CLE A EMBOUT SPHERIQUE  
ZESKANTSCHROEVENDRAAIERS met kogelkop

GORREUX



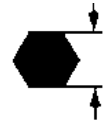

CHROME VANADIUM, trempée et à teinte brunie par revenu  
CHROOM-VANADIUM, uitv. gehard, ontlaten en gezwart

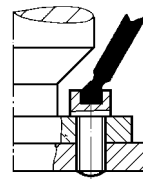

Domaine d'utilisation : jusqu'à un angle de 30° - travail rapide possible à des endroits difficilement accessibles - introduction aisée et pourtant exacte dans le profil intérieur de la vis

Schroevendraaiers met kogelvormige kop zijn bestemd voor het aandraaien van binnenzeskantschroeven op moeilijk bereikbare plaatsen onder een hoek van maximaal 30°



CODE	 mm	 pouce / duim	 mm	
960000122	1,5		90 X 14	2
960000123	2	5 / 64	100 X 16	3
960000124	2,5		112 X 18	6
4583	3		126 X 20	9
4584	4	5 / 32	140 X 25	19
4585	5		160 X 28	34
4586	6	5 / 16	180 X 32	54
4587	8		200 X 36	110
4588	10		224 X 40	190
960000125	12		250 X 45	295

DIN 911LG-D

CLE A EMBOUT SPHERIQUE  
ZESKANTSCHROEVENDRAAIERS met kogelkop

GORREUX



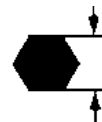

CHROME VANADIUM, trempée et chromée  
CHROOM-VANADIUM, uitv. gehard, en vernikkeld

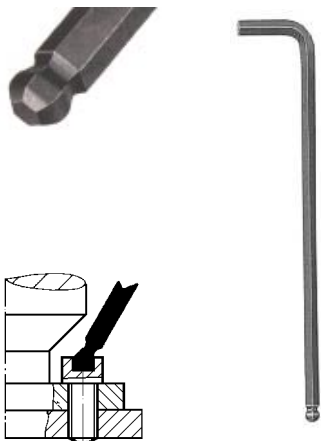

Domaine d'utilisation : jusqu'à un angle de 30° - travail rapide possible à des endroits difficilement accessibles - introduction aisée et pourtant exacte dans le profil intérieur de la vis

Schroeevedraaiers met kogelvormige kop zijn bestemd voor het aandraaien van binnenzeskantschroeven op moeilijk bereikbare plaatsen onder een hoek van maximaal 30°



CODE	 mm	 pouce / duim	 mm	
4911	1,5		90 X 14	2
4912	2	5 / 64	100 X 16	3
4913	2,5		112 X 18	6
4914	3		126 X 20	9
4915	4	5 / 32	140 X 25	19
4916	5		160 X 28	34
4917	6	5 / 16	180 X 32	54
4918	8		200 X 36	110
4919	10		224 X 40	190
4920	12		250 X 45	295

906 QG

CLE A EMBOUT SPHERIQUE  
ZESKANTSCHROEVENDRAAIERS met kogelkop

GORREUX



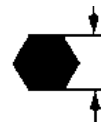

CHROME VANADIUM, trempée et à teinte brunie par revenu  
CHROOM-VANADIUM, uitv. gehard, ontlaten en gezwart

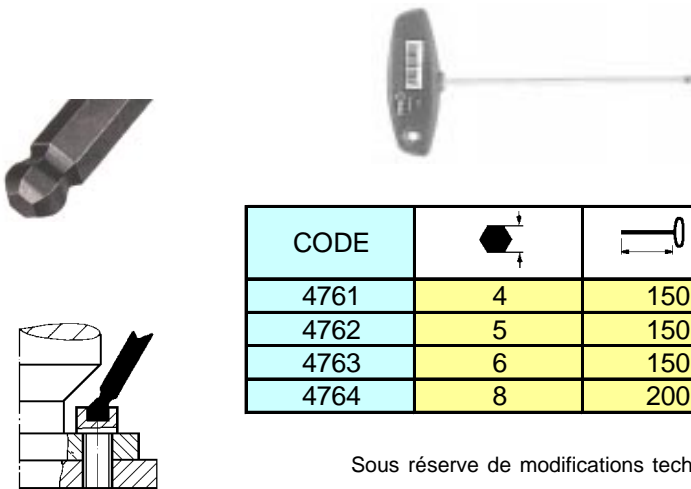

Domaine d'utilisation : jusqu'à un angle de 30° - travail rapide possible à des endroits difficilement accessibles - introduction aisée et pourtant exacte dans le profil intérieur de la vis

Schroeevedraaiers met kogelvormige kop zijn bestemd voor het aandraaien van binnenzeskantschroeven op moeilijk bereikbare plaatsen onder een hoek van maximaal 30°



CODE					
4761	4	150	80	175	40
4762	5	150	100	181	65
4763	6	150	100	181	80
4764	8	200	100	231	130

Sous réserve de modifications techniques - technische wijzigingen voorbehouden

906G

CLE A EMBOUT SPHERIQUE  
ZESKANTSCHROEVENDRAAIERS met kogelkop







CHROME VANADIUM, trempée et à teinte brunie par revenu  
CHROOM-VANADIUM, uitv. gehard, ontlaten en gezwart

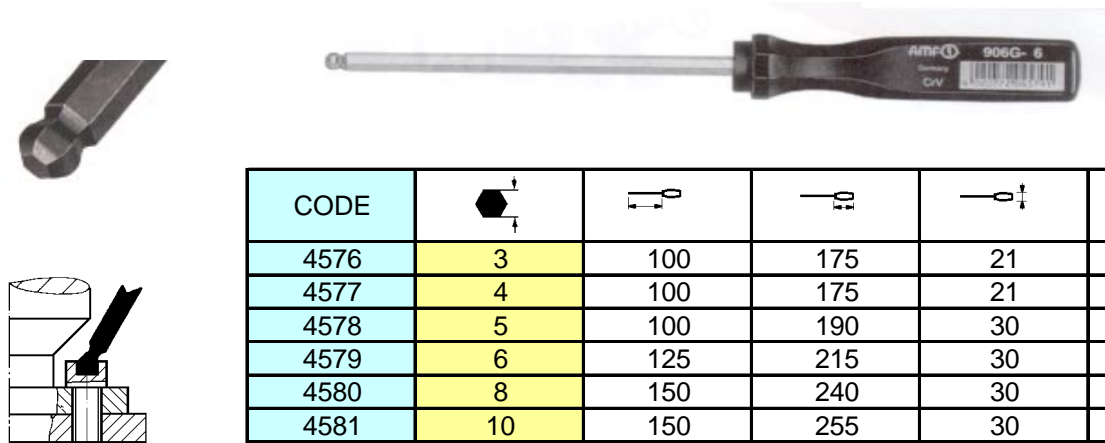

Domaine d'utilisation : jusqu'à un angle de 30° - travail rapide possible à des endroits difficilement accessibles - introduction aisée et pourtant exacte dans le profil intérieur de la vis

Schroevendraaiers met kogelvormige kop zijn bestemd voor het aandraaien van binnenzeskantschroeven op moeilijk bereikbare plaatsen onder een hoek van maximaal 30°



CODE					$\Delta \Delta$
4576	3	100	175	21	35
4577	4	100	175	21	50
4578	5	100	190	30	75
4579	6	125	215	30	110
4580	8	150	240	30	155
4581	10	150	255	30	215

911LG-WM7

JEUX DE CLE A EMBOUT SPHERIQUE  
STELLEN ZESKANTSCHROEVENDRAAIERS





CHROME VANADIUM, trempée et nickelée.  
CHROOM-VANADIUM, uitv. gehard, en vernikkeld

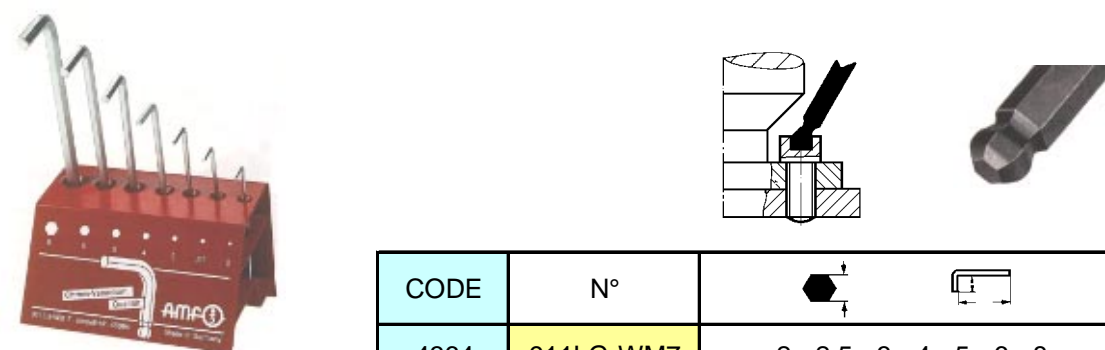

Domaine d'utilisation : jusqu'à un angle de 30° - travail rapide possible à des endroits difficilement accessibles - introduction aisée et pourtant exacte dans le profil intérieur de la vis

Schroevendraaiers met kogelvormige kop zijn bestemd voor het aandraaien van binnenzeskantschroeven op moeilijk bereikbare plaatsen onder een hoek van maximaal 30°



CODE	N°			$\Delta \Delta$
4364	911LG-WM7	2 - 2,5 - 3 - 4 - 5 - 6 - 8		730
4406	911LG-WM9	2 - 2,5 - 3 - 4 - 5 - 6 - 8 - 10		1120

911LG-HMC

## JEUX DE CLE POUR SIX-PANS CREUX STELLEN ZESKANTSCHROEVENDRAAIERS



CHROME VANADIUM, trempée et nickelée.



CHROOM-VANADIUM, uitv. gehard, en vernikkeld

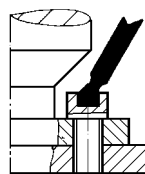

Domaine d'utilisation : jusqu'à un angle de 30° - travail rapide possible à des endroits difficilement accessibles - introduction aisée et pourtant exacte dans le profil intérieur de la vis

Schroevendraaiers met kogelvormige kop zijn bestemd voor het aandraaien van binnenzeskantschroeven op moeilijk bereikbare plaatsen onder een hoek van maximaal 30°



CODE	N°			
4622	911LG-HM7C	1,5 - 2 - 2,5 - 3 - 4 - 5 - 6		140
4623	911LG-HM9C	1,5 - 2 - 2,5 - 3 - 4 - 5 - 6 - 8 - 10		440
4925	911LG-HM9D	1,5 - 2 - 2,5 - 3 - 4 - 5 - 6 - 8 - 10		440

911LG-TM8

## JEUX DE CLE POUR SIX-PANS CREUX STELLEN ZESKANTSCHROEVENDRAAIERS



CHROME VANADIUM, trempée et nickelée.



CHROOM-VANADIUM, uitv. gehard, en vernikkeld

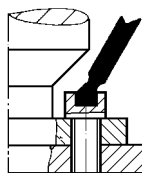

Domaine d'utilisation : jusqu'à un angle de 30° - travail rapide possible à des endroits difficilement accessibles - introduction aisée et pourtant exacte dans le profil intérieur de la vis

Schroevendraaiers met kogelvormige kop zijn bestemd voor het aandraaien van binnenzeskantschroeven op moeilijk bereikbare plaatsen onder een hoek van maximaal 30°



CODE	N°			
4604	911LG-TM8	1,5 - 2 - 2,5 - 3 - 4 - 5 - 6 - 8		250

911LG-BMC

JEUX DE CLE POUR SIX-PANS CREUX  
STELLEN ZESKANTSCHROENVEDRAAIERS



CHROME VANADIUM, trempée et nickelée.





CHROOM-VANADIUM, uitv. gehard, en vernikkeld

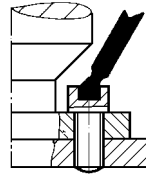

Domaine d'utilisation : jusqu'à un angle de 30° - travail rapide possible à des endroits difficilement accessibles - introduction aisée et pourtant exacte dans le profil intérieur de la vis

Schroeevedraaiers met kogelvormige kop zijn bestemd voor het aandraaien van binnenzeskantschroeven op moeilijk bereikbare plaatsen onder een hoek van maximaal 30°



CODE	N°			L X H X B	△△
4601	911LG-BM8C	1,5 - 2 - 2,5 - 3 - 4 - 5 - 6 - 8 - 10		265 X 88 X 17	530
4927	911LG-BM8D	1,5 - 2 - 2,5 - 3 - 4 - 5 - 6 - 8 - 10		265 X 88 X 17	530

911G-TM7

JEUX DE CLE POUR SIX-PANS CREUX  
STELLEN ZESKANTSCHROEVENDRAAIERS



CHROME VANADIUM, trempée et nickelée.





CHROOM-VANADIUM, uitv. gehard, en vernikkeld

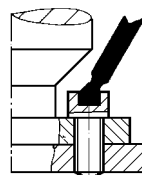

Domaine d'utilisation : jusqu'à un angle de 30° - travail rapide possible à des endroits difficilement accessibles - introduction aisée et pourtant exacte dans le profil intérieur de la vis

Schroeevedraaiers met kogelvormige kop zijn bestemd voor het aandraaien van binnenzeskantschroeven op moeilijk bereikbare plaatsen onder een hoek van maximaal 30°



CODE	N°			L X B X H	△△
4365	911LG-TM7	1,5 - 2 - 2,5 - 3 - 4 - 5 - 6			75
4602	911G-BM10	2 - 2,5 - 3 - 4 - 5 - 6 - 8 - 10		170 X 88 X 17	270



908

CLE TORX COUDEE  
TORXSCHROEVENDRAAIERS



CHROME VANADIUM, trempée et à teinte brunie par revenu  
CHROOM-VANADIUM, uitv. gehard, ontlaten en gezwart



CODE	 A			
5621	T6	1,7	38X16	1,9
5622	T7	1,99	41X16	2
5623	T8	2,31	44X16	2,8
5624	T9	2,5	48X16	3,4
5625	T10	2,74	51X14	3,6
5626	T15	3,27	54X18	5,2
5627	T20	3,86	57X19	6,5
5628	T25	4,43	60X20	9,4
5629	T27	4,99	63X21	15
5630	T30	5,52	70X24	20
5631	T40	6,65	76X26	31
5632	T45	7,82	82X28	44
5633	T50	8,83	95X32	62
5634	T55	11,22	108X35	126





907S

CLE TORX A PETITE POIGNEE  
TORXSCHROEVENDRAAIERS



CHROME VANADIUM, trempée et à teinte brunie par revenu  
CHROOM-VANADIUM, uitv. gehard, ontlaten en gezwart



CODE	 A					
4673	T6	1,7	50	85	40	14
4674	T7	1,99	50	85	40	14
4675	T8	2,31	50	85	40	14
4676	T9	2,5	50	85	40	15
4677	T10	2,74	50	85	40	15



907L

TOURNEVIS TORX  
TORXSCHROEVENDRAAIERS







CHROME VANADIUM, trempée et à teinte brunie par revenu  
CHROOM-VANADIUM, uitv. gehard, ontlaten en gezwart



**TORX®**



CODE	 A					
4635	T8	2,31	60	135	16	25
4636	T9	2,5	60	145	18	39
4642	T10	2,74	80	175	21	55
4637	T15	3,27	80	175	21	55
4638	T20	3,86	100	205	24	76
4639	T25	4,43	100	205	24	79
4640	T27	4,99	115	230	24	79
4641	T30	5,52	115	230	27	116

907Q

CLE TORX A POIGNEE  
TORXSCHROEVENDRAAIERS









CHROME VANADIUM, trempée et à teinte brunie par revenu  
CHROOM-VANADIUM, uitv. gehard, ontlaten en gezwart



**TORX®**



CODE	 A					
4590	T9	2,5	100	80	125	35
4591	T10	2,74	100	80	125	35
4592	T15	3,27	100	80	125	36
4593	T20	3,86	100	100	125	60
4594	T25	4,43	100	100	125	60
4595	T27	4,99	100	100	131	70
4596	T30	5,52	100	100	131	75
4597	T40	6,65	100	100	131	80
4598	T45	7,82	150	120	188	140
4599	T50	8,83	150	120	188	160
4600	T55	11,22	150	120	188	230



907Q-WT7	<b>JEUX DE CLE POUR SIX-PANS CREUX</b> <b>STELLEN ZESKANTSCHROEVENDRAAIERS</b>	
----------	---	---



CHROME VANADIUM, trempée et nickelée.  
 CHROOM-VANADIUM, uitv. gehard, en vernikkeld



**TORX®**

CODE		
4650	T10x100, 15x100, 20x100,t25x100, 30x100, 40x100, 50x150	660



908 TT9	<b>JEUX DE CLE POUR SIX-PANS CREUX</b> <b>STELLEN ZESKANTSCHROEVENDRAAIERS</b>	
---------	---	---



CHROME VANADIUM, trempée et à teinte brunie par revenu  
 CHROOM-VANADIUM, uitv. gehard, ontlaten en gezwart

**TORX®**



CODE		
4652	T6,7,8,9,10,15,20,25,30	65



910 T	<b>JEUX DE CLE MULTISERVICE</b> <b>STELLEN ZESKANTSCHROEVENDRAAIERS</b>	
-------	--	---



CHROME VANADIUM, trempée et à teinte brunie par revenu  
 CHROOM-VANADIUM, uitv. gehard, ontlaten en gezwart

**TORX®**



CODE			
4483	95 x 28 x 25	T8,9,10,15,20,25,27,30	200





DIN 1810A

## CLES A ERGOT HAAKSLEUTELS

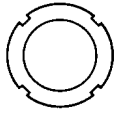

**DIN 1810 A Clé à ergot plat avec nez pour écrous à créneaux DIN 1804**  
**DIN 1810 A Haaksleutels met neus voor gleufmoeren DIN 1804**



CODE	Gr.		DIN 1804 (M)			
5458	12 - 14			110	3	25
5459	16 - 20		6-8	110	3	25
5460	25 - 28		10-12	136	4	45
5461	30 - 32		14-16	136	4	50
5462	34 - 36		18-20	170	5	90
5463	40 - 42		22-24	170	5	90
5464	45 - 50		26-30	206	6	155
5465	52 - 55		32-35	206	6	160
5466	58 - 62		38-42	242	7	255
5467	68 - 75		45-50	242	7	255
5468	80 - 90		52-60	280	8	410
5469	95 - 100		62-70	280	8	385
5470	110 - 115		72-80	335	10	745
5471	120 - 130		85-90	335	10	720
5416	135 - 145		95-100	385	10	1000
5418	155 - 165		105-120	385	10	965
5420	180 - 195		125-140	470	10	1580
5422	205 - 220		150-160	470	10	1580
5424	230 - 245		170-180	560	10	2250
5426	260 - 270		190-200	568	10	2250
5427	280 - 300		-	680	16	5000
5428	300 - 320		-	695	16	5100
5429	320 - 345		-	695	16	5200
5430	350 - 375		-	735	16	5200
5431	380 - 400		-	770	16	6700
5432	480 - 500		-	988	20	13000

771

## CLE A CROCHET REGLABLE VERSTELBARE HAAKSLEUTELS MET NEUS







EXEC : Acier spécial meulée et à teinte brunie par revenu

UITV : speciaalstaal fijn geslepen, gehard, ontlaten en gezwart

Pour écrous à encoches DIN 1804

Voor gleufmoeren DIN 1804



CODE	Gr.				
5157	20-42		180	4	100
5158	45-90		240	6	240
5159	95-165		335	10	700

112

Sous réserve de modifications techniques - technische wijzigingen voorbehouden

775C

CLE A CROCHET ARTICULEE  
SCHARNIERENDE HAAKSLEUTELS MET NEUS







EXEC : Acier spécial meulée sur chant, trempée et à teinte brunie par revenu

UITV : speciaalstaal fijn geslepen, gehard, ontlaten en gezwart

Pour écrous à encoches DIN 1804

Voor gleufmoeren DIN 1804



CODE	Gr.		DIN 1804	DIN 981			
5164	20- 35		8-18	12-20	135/4	7	50
5165	35- 60		20-38	25-40	175/5	10	100
5166	60- 90		40-60	45-65	250/7	13	280
5167	90- 155		58-110	70-120	290/8	14,5	460
5168	155- 230		105-170	120-180	420/10	18,5	1200

775D

CLE A CROCHET ARTICULEE  
SCHARNIERENDE HAAKSLEUTELS MET NEUS







EXEC : Acier spécial meulée sur chant, trempée et nickelée

UITV : speciaalstaal fijn geslepen, gehard, en vernikkeld

Pour écrous à encoches DIN 1804

Voor gleufmoeren DIN 1804



CODE	Gr.		DIN 1804	DIN 981			
5173	20- 35		8-18	12-20	135/3	9	50
5174	35- 60		20-38	25-40	175/4	10,5	100
5175	60- 90		40-60	45-65	250/5	12,5	280
5176	90- 155		58-110	70-120	290/6	14	460
5177	155- 230		105-170	120-180	420/8	17,5	1150

775NI

CLE A CROCHET ARTICULEE  
SCHARNIERENDE HAAKSLEUTELS MET NEUS



EXEC : Acier Inox

Pour écrous à encoches DIN 1804





UITV : speciaalstaal RVS

Voor gleufmoeren DIN 1804

Pour raccords vissants et robinetterie selon DIN 11851

Voor koppelingen en armaturen volgens DIN 11851



CODE	Gr.		DIN 1804	DIN 981	DIN 11851			
5218	20- 35		8-18	12-20		135/3	9	50
5219	35- 60		20-38	25-40	10-20	175/4	10,5	100
5220	60- 90		40-60	45-65	25-40	250/5	12,5	280
5221	90- 155		58-110	70-120	50-100	290/6	14	460
5222	155- 230		105-170	120-180	125-150	420/8	17,5	1150

Sous réserve de modifications techniques - technische wijzigingen voorbehouden

DIN 1810B

## CLES A ERGOT HAAKSLEUTELS









EXEC : Acier spécial meulée sur chant, trempée et à teinte brunie par revenu

UITV : speciaalstaal fijn geslepen, gehard, ontlaten en gezwart

DIN 1810 B Clé à ergot rond pour écrous à trous latéraux DIN 1816

DIN 1810 B Haaksleutels met pen voor kruisgatmoeren DIN 1816



CODE	Gr.						
5487	12 - 14	2	2	110	3	25	
5488	16 - 18	2,5	2,5	110	3	25	
5489	20 - 22	2,5	2,5	110	3	40	
5490	25 - 28	3	3	136	4	55	
5491	30 - 32	4	3	136	4	55	
5492	34 - 36	4	3,5	170	5	100	
5493	40 - 42	4	3,5	170	5	100	
5494	45 - 50	5	4	205	6	165	
5495	52 - 55	5	4	205	6	165	
5496	58 - 62	5	5	240	7	270	
5497	68 - 75	6	5	240	7	270	
5498	80 - 90	6	6	280	8	410	
5499	95 - 100	8	6	280	8	410	
5500	110 - 115	8	8	335	10	780	
5501	120 - 130	8	8	335	10	780	
5502	135 - 145	8	8	380	10	1000	
5503	155 - 165	8	8	380	10	1000	
5504	180 - 195	10	8	470	10	1580	
5505	205 - 220	10	8	470	10	1580	
5506	230 - 245	10	10	560	10	2250	
5507	260 - 270	10	10	570	10	2250	

776C

## CLE A ERGOT ARTICULEE SCHARNIERENDE HAAKSLEUTELS MET PENNEN









EXEC : Acier spécial meulée sur chant, trempée et à teinte brunie par revenu

UITV : speciaalstaal fijn geslepen, gehard, ontlaten en gezwart

Pour écrous cylindriques à trous périphériques précés en DIN 1816

Voor kruisgatmoeren DIN 1816



code						
5182	20- 35	2,5	135	4	7	50
5183	20- 35	3	135	4	7	50
5184	20- 35	4	135	4	7	50
5185	35- 60	4	175	5	10	100
5186	35- 60	5	175	5	10	100
5187	60- 90	5	250	7	13	280
5188	60- 90	6	250	7	13	280
5189	90- 155	6	290	8	14,5	460
5190	90- 155	8	290	8	14,5	460
5191	155- 230	8	420	10	18,5	1200
5192	155- 230	10	420	10	18,5	1200

776D

## CLE A ERGOT ARTICULEE SCHARNIERENDE HAAKSLEUTELS MET PENNEN

EXEC : Acier spécial meulée sur chant, trempée et nickelée

UITV : speciaalstaal fijn geslepen, gehard, en vernikkeld

Pour écrous cylindriques à trous périphériques précés en DIN 1816

Voor kruigatmoeren DIN 1816



CODE						
5197	20- 35	2,5	135	4	7	50
5198	20- 35	3	135	4	7	50
5199	35- 60	4	175	5	10	100
5200	60- 90	5	250	7	13	280
5204	90- 155	6	290	8	14,5	460
5206	155- 230	8	420	10	18,5	1200

758-759AZ

## CLE A ERGOT REGLABLE VERSTELBARE PENGATSLEUTELS

A ergots trempés interchangeables

EXEC : Acier spécial meulée sur chant, trempée et à teinte brunie par revenu

UITV : speciaalstaal fijn geslepen, gehard, ontlaten en gezwart

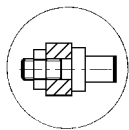
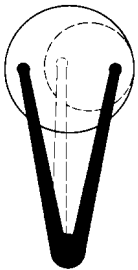

CODE	N°						
4064	758AZ	11-60	3	4	160	4	20
4065	758AZ	11-60	4	5	160	4	20
4066	758AZ	11-60	5	6	160	4	20
4085	759AZ	14-100	5	6	215	6	10
4086	759AZ	14-100	6	7	215	6	10
4087	759AZ	14-100	8	8	215	6	10

764AZ

## CLE A ERGOT REGLABLE VERSTELBARE PENGATSLEUTELS

A ergots trempés interchangeables

EXEC : Acier spécial meulée sur chant, trempée et à teinte brunie par revenu

UITV : speciaalstaal fijn geslepen, gehard, ontlaten en gezwart

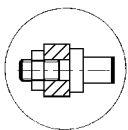
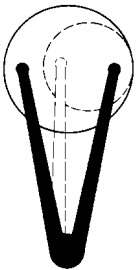

CODE	N°						
4120	764AZ	18-40	3	4	150	5	90
4121	764AZ	18-40	4	5	150	5	90
4122	764AZ	40-80	4	5	220	6	245
4123	764AZ	40-80	5	6	220	6	245
4124	764AZ	40-80	6	7	220	6	245
4125	764AZ	80-125	6	7	320	8	670
4126	764AZ	80-125	7	7,5	320	8	670
4127	764AZ	80-125	8	8	320	8	670
4128	764AZ	125-200	8	8	450	10	1750
4129	764AZ	125-200	10	10	450	10	1750



764AZ-04

## ERGOT NON FIXE AVEC ECROU PEN



EXEC : Acier spécial meulée sur chant, trempée et à teinte brunie par revenu  
 UITV : speciaalstaal fijn geslepen, gehard, ontlaten en gezwart

APour clés n° 758AZ-759AZ-764AZ ergots trempés interchangeableables

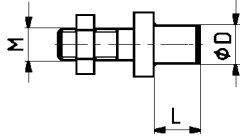

CODE	N°	758AZ	759AZ	764AZ	D	L	M
4779	764AZ-04-02	11-60	-	18-40	3	4	M4
4780	764AZ-04-03	11-60	-	18-40	4	5	M4
4777	764AZ-04-04	11-60	-	-	5	6	M4
4781	764AZ-04-07	-	-	40-80	4	5	M5
4782	764AZ-04-08	-	-	40-80	5	6	M5
4783	764AZ-04-09	-	-	40-80	6	7	M5
4778	764AZ-04-11	-	14-100	-	5	6	M6
4784	764AZ-04-12	-	14-100	80-125	6	7	M6
4785	764AZ-04-13	-	-	80-125	7	7,5	M6
4786	764AZ-04-14	-	14-100	80-125	8	8	M6
4787	764AZ-04-17	-	-	125-200	8	8	M8
4788	764AZ-04-19	-	-	125-200	10	10	M8

756-760







## CLE A ERGOT REGLABLE VERSTELBARE PENGATSLEUTELS

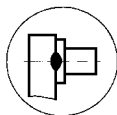
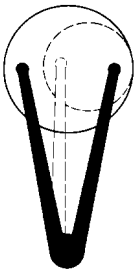

A ergots trempés rivés (756) , soudés (758-759-760)

EXEC : Acier spécial meulée sur chant, trempée et à teinte brunie par revenu  
 UITV : speciaalstaal fijn geslepen, gehard, ontlaten en gezwart



CODE	N°						
4047	756	7-40	1,5	2,8	115	3	40
4048	756	7-40	2	3,6	115	3	40
4049	756	7-40	2,5	4	115	3	40
4061	758	11-60	3	4	160	4	20
4062	758	11-60	4	5	160	4	20
4063	758	11-60	5	6	160	4	20
4075	759	14-100	5	6	215	6	10
4076	759	14-100	6	7	215	6	10
4077	759	14-100	8	8	215	6	10
4089	760	22-125	8	8	260	6	500
4090	760	22-125	10	10	260	6	500
4091	760	22-125	12	12	260	6	500

764C

## CLE A ERGOT REGLABLE VERSTELBARE PENGATSLEUTELS

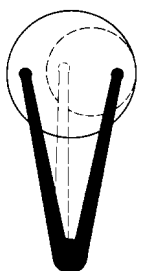





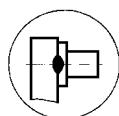

A ergots trempés, soudés électriquement

EXEC : Acier spécial meulée sur chant, trempée et à teinte brunie par revenu

UITV : speciaalstaal fijn geslepen, gehard, ontlaten en gezwart



CODE	N°						
4103	764AZ	18-40	3	4	150	5	90
4104	764AZ	18-40	4	5	150	5	90
4105	764AZ	40-80	4	5	220	6	245
4106	764AZ	40-80	5	6	220	6	245
4107	764AZ	40-80	6	7	220	6	245
4108	764AZ	80-125	6	7	320	8	670
4109	764AZ	80-125	7	7,5	320	8	670
4110	764AZ	80-125	8	8	320	8	670
4111	764AZ	125-200	8	8	450	10	1750
4112	764AZ	125-200	10	10	450	10	1750

DIN 3116

## CLE POUR ECROUS A DEUX TROUS PENGATSLEUTEL vorm A vlak

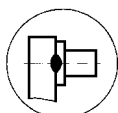









A ergots trempés, soudés électriquement

EXEC : Acier spécial galvanisée

UITV : speciaalstaal



CODE	FORME							
4466	A	35	5	6	-	180	5	120
4467	C	35	5	6	50	200	5	200
4468	C	35	5,5	6	50	200	5	200

DIN 3116A

## CLE POUR ECROUS A DEUX TROUS PENGATSLEUTEL vorm A vlak

GORREUX

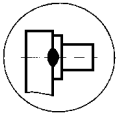

A ergots trempés, soudés électriquement

EXEC : Acier spécial meulée sur chant, trempée et à teinte brunie par revenu

UITV : speciaalstaal fijn geslepen, gehard, ontlaten en gezwart



CODE							$\frac{A}{A}$
4445	13	2,5	4	117	3	42	
4446	15	3	4	117	3	42	
4447	20	3	4	126	4	55	
4462	20	4	5	126	4	55	
4463	25	3	4	145	4	65	
4448	25	4	5	145	4	65	
4449	30	4	5	164	5	105	
4464	35	5	6	180	5	130	
4450	35	4	5	180	5	120	
4451	40	4	5	176	5	125	
4452	45	4	5	186	5	140	
4453	50	5	6	198	5	160	
4454	60	5	6	208	6	227	
4455	75	6	7	245	6	315	
4456	90	7	7,5	275	8	540	

DIN 3116C

## CLE POUR ECROUS A DEUX TROUS PENGATSLEUTEL vorm A vlak

GORREUX

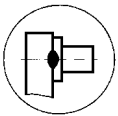

A ergots trempés, soudés électriquement

EXEC : Acier spécial galvanisée

UITV : speciaalstaal



CODE							$\frac{A}{A}$
4469	18	3	4	15	140	4	95





250

CLE POUR ECROUS pinces de serrage  
PENGATSLEUTEL



A ergots trempés, soudés électriquement  
EXEC : Acier spécial galvanisée  
UITV : speciaalstaal



CODE	N°				
5224	16	32	163	5	180
5225	20	35	183	5	190
5226	25	42	203	6	255
5227	32	50	253	6	359
5228	40	63	285	7	550



DIN 317

CHASSE-CONE  
UITDRIJVERS



DIN 317 Chasse-cône pour cône d'outillage DIN 228  
DIN 317 Uitdrijvers voor gereedschapconussen DIN 228



CODE	Grandeur / grotte	pour cône / voor conus morse				
		métrique	/ morse / metric			
4014	0	0	4 + 6	90	12 X 3	14
4015	1	1 + 2	-	140	20 X 5	70
4016	3	2	-	190	25 X 7	150
4017	4	4	-	225	30 X 10	310
4018	5	5	-	265	35 X 15	650



318

CHASSE-CONE  
UITDRIJVERS

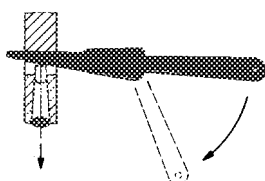

No. 318 Chasse-cône semi-automatique pour cône d'outillage DIN 228  
Nr. 318 Uitdrijvers halfautomatisch voor gereedschapconussen DIN 228



CODE	Grandeur / grotte	pour cône morse voor morse-conus		
4022	1 - 3	1 - 3	317	310
4023	4 - 6	4 - 6	380	570

Sous réserve de modifications techniques - technische wijzigingen voorbehouden 119

960

## CLE A DOUILLE POUR TUYAU A REFRIGERANT

### Sleutel met mof voor koelleiding

TIGE: acier spécial ; à teinte brunie par revenu  
 POIGNEE: en matière plastique noire (exempte de cadmium), résistant aux chocs

Schacht : speciaal staal; ontlaten en gezwart.  
 Handvat : in zwart plastic (cadmiumvrij), schokbestendig



CODE	N°					
5700	32	90	80	115	8,5	50
5701	40	90	80	115	10,5	60
5702	50	90	80	115	14,5	75
5703	63	105	100	136	16,5	125
5704	80	105	100	136	18,5	165
5705	100	105	100	136	22	135

6368

## CLES POUR MANDRINS PORTE\_FRAISE

### SLEUTELS VOOR OPSTEEKFREESDOORNS

pour le blocage fiable de vis de serrage de fraise  
 selon DIN 6367  
 acier spécial; trempée et a teinte brunie par  
 revenu

Voor freesslitschroeven volgens DIN 6367  
 Speciaal staal; gehard, ontlaten en gezwart



CODE					
4472	13	M6	13	160	65
4473	16	M8	16	180	85
4474	22	M10	22	200	200
4475	27	M12	27	225	400
4476	32	M16	32	250	570
4477	40	M20	40	280	800
4478	50	M24	50	315	1100
4479	60	M30	60	355	1750

6368s

## CLES POUR MANDRINS PORTE-FRAISE

### SLEUTELS VOOR OPSTEEKFREESDOORNS

pour le blocage fiable de vis de serrage de  
 fraise selon DIN 6367 plus de glissement lors  
 du blocage de vis de serrage de fraise !

Voor het betrouwbaar blokkeren van freesslitschroeven  
 volgens DIN 6367

Niet langer uitschuiven bij het blokkeren van  
 freesslitschroeven !



120

CODE					
4473	16	M8	16	180	215
4474	22	M10	22	200	330
4475	27	M12	27	225	530
4476	32	M16	32	250	700
4477	40	M20	40	280	930
4478	50	M24	50	315	1230

Sous réserve de modifications techniques - technische wijzigingen voorbehouden

916Q

## CLE A DOUILLE A SIX-PANS CREUX

### Zeskantdopsleutels









TIGE : CHROME- VANADIUM trempée et nickelée

POIGNEE: en matière plastique noire (exempte de cadmium) résistant aux chocs.

SCHACHT: Chromo-vandium, gehard en vernikkeld

HANDVAT: in zwart plastisch materiaal (vrij van cadmium), schokbestendig



CODE						
4711	5,5	125	100	156	8	80
4712	6	125	100	156	9	82
4713	7	125	100	156	11	90
4714	8	125	100	156	12	95
4715	8	200	100	231	12	110
4716	8	350	100	381	12	150
4717	9	125	100	156	13	115
4718	9	350	100	381	13	210
4719	10	125	100	156	14	125
4720	10	230	100	261	14	160
4721	10	350	100	381	14	220
4722	11	125	100	156	16	130
4723	11	350	100	381	16	225
4724	12	125	100	156	17	135
4725	12	350	100	381	17	230
4726	13	125	100	156	19	140
4727	13	230	100	261	19	180
4728	13	350	100	381	19	235
4729	14	125	100	156	20	140
4730	14	350	100	381	20	235
4731	15	125	100	156	22	155
4732	16	125	100	156	22	155
4733	17	125	100	156	24	155

DIN 22417

## CLE EN TUBE POUR TETES TRIANGULAIRES





### Buissleutel met driehoekige kop



acier spécial.tige et broche de manoeuvre galvanisée

Speciaal staal. Schacht en bedieningsspil gegalvaniseerd







CODE					
4435	M4	90X9	6,8	50x4	20
4436	M5	100X10	8,3	63x5	30
4437	M6	112X13	10,05	80X6	60
4438	M8	125X15	12,05	100X6	80
4439	M10	140X18	15,05	125X8	160
4440	M12	160X20	16,55	160X10	240
4441	M16	180X26	20,55	200X12	400



ACIER spécial; trempée et à teinte brunie par revenu



STAAL: speciaal, gehard en met bruine kleur door ontlaten



CODE				
4025	6	110	5,3	18
4026	8	110	6,3	20
4027	9	110	6,3	40
4028	10	125	6,3	50
4029	11	125	6,3	90
4030	13	145	8,5	90
4031	14	145	8,5	90
4032	17	155	10,5	130
4033	19	160	12,5	170
4034	22	170	12,5	220
4035	24	190	14,5	270
4036	27	190	14,5	315
4037	30	205	16,5	450
4038	32	225	16,5	510
4039	36	225	16,5	670
4040	41	245	18,5	1000
4041	46	245	21	1100
4042	50	245	21	1550

BROCHE DE MANOEUVRE POUR DIN 659 ET DIN 896B  
acier spécial ;trempée et à teinte brunie par revenu

BEDIENINGSSPIL VOOR DIN 659 en DIN 896B  
STAAL: speciaal, gehard en met bruine kleur door ontlaten

CODE	$\varnothing$		
4153	5	125	20
4154	6	160	40
4155	8	180	70
4156	10	200	125
4157	12	250	220
4158	14	320	390
4159	16	400	630
4160	18	500	990
4161	20	630	1550

DIN 904

## CLE A BEQUILLE STEEKSLEUTELS

DIN 904 Clé à bécuille 4 pans femelle  
DIN 904 Vierkant-opsteeksleutels

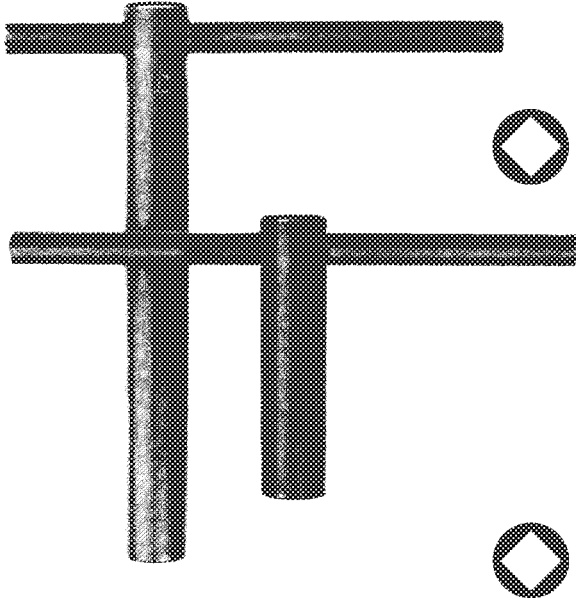

DIN 904L Série longue  
DIN 904L Lange uitvoering

CODE				
4166	4	60 X 12	160 X 6	85
4167	5	60 X 12	160 X 6	85
4168	6	80 X 12	160 X 6	100
4169	7	80 X 16	180 X 8	180
4170	8	80 X 16	180 X 8	180
4171	9	100 X 18	180 X 8	245
4172	10	100 X 20	200 X 10	340
4173	12	100 X 24	250 X 12	520
4174	13	100 X 24	250 X 12	520
4175	14	120 X 28	320 X 14	875
4176	17	160 X 34	400 X 16	1625
4177	19	200 X 36	400 X 16	2035
4178	22	200 X 42	500 X 18	2900
4179	24	250 X 45	630 X 20	4270

CODE				
4184	5	120 X 12	160 X 6	100
4185	6	160 X 12	160 X 6	110
4186	(8)	160 X 16	180 X 8	210
4187	9	200 X 18	200 X 8	390
4188	10	200 X 20	200 X 10	390
4189	12	200 X 24	250 X 12	600
4190	13	200 X 24	250 X 12	600
4191	14	200 X 28	320 X 14	795
4192	17	250 X 34	400 X 16	1500
4193	19	320 X 36	400 X 16	1700

DIN 905

## CLE A BEQUILLE STEEKSLEUTELS

DIN 905 Clé à bécuille 4 pans mâle  
DIN 905 Vierkant-insteeksleutels

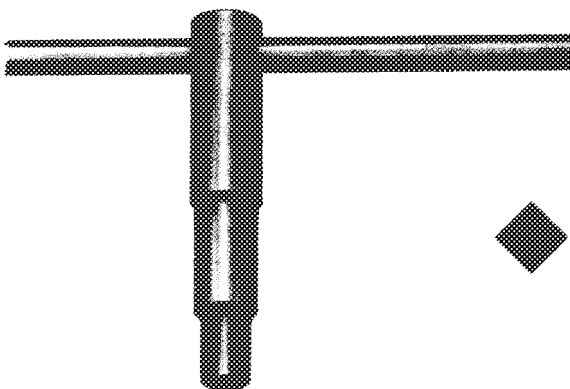

CODE				
4198	4	60 X 12	160 X 6	70
4199	5	60 X 12	160 X 6	70
4200	6	80 X 12	160 X 6	80
4201	7	80 X 16	180 X 8	170
4202	8	80 X 16	180 X 8	170
4203	9	80 X 16	180 X 8	170
4204	10	100 X 20	200 X 10	320
4205	11	100 X 20	200 X 10	320
4206	12	100 X 24	250 X 12	450
4207	13	100 X 24	250 X 12	450
4208	14	120 X 28	320 X 14	780
4209	17	160 X 34	400 X 16	1500
4210	19	200 X 36	400 X 16	2100
4211	22	200 X 42	630 X 20	3100
4212	24	250 X 45	630 X 20	4200

DIN 248



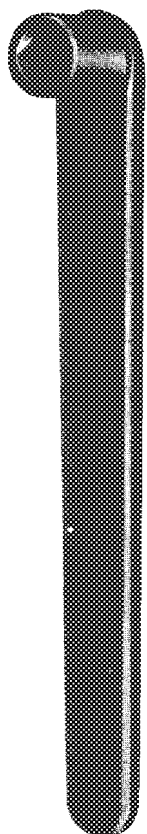

CLE A DOUILLE  
STEEK-EN DOORNSLEUTELS

GORREUX



DIN 248 Clé 4 pans à manche  
DIN 248 Vierkant - schroef sleutels



CODE				
4002	8	165	17,5	130
4003	10	205	21,5	210
4004	12	245	24,5	340
4005	14	278	27,5	520
4006	17	328	32	780
4007	19	360	35	100
4008	22	402	39,5	1650
4009	24	435	43	1900

DIN 7417





CLE A TETE CARREES  
DOORNSLEUTEL BINNENVIERKANT

GORREUX

Fonte malléable, nickelee

Gesmeed gietijzer, vernikkeld



CODE				
5600	6	55	11	18
5601	7	52	12	18
5602	8	58	14	24
5604	10	64	17	40